

Undergraduate Common Entrance Examination for Design

UCEED 2021
PAPER

Paper Specific Instructions

1. The total duration of the examination is 3 hours. The question paper contains two parts – Part A and Part B. The duration of Part A is **2 hours and 30 minutes**. Part B will begin after Part A ends. Part A is divided into three sections, 1, 2 and 3. All sections are compulsory. Questions in each section are of different types. There are a total of **68 questions** carrying a total of 240 marks. Questions of Part A will appear on the computer. Answers to **Part A** have to be entered in the **computer**. **Part B** is also compulsory and contains **1 drawing question** of 60 marks.
2. Marking scheme of Part A is as follows:

Section	Number of questions	Marks for each correct answer	Marks for each wrong answer	Marks for each question not attempted	Total marks for the section
NAT	18	4	0	0	72
MSQ	18	4	-0.19	0	72
MCQ	32	3	-0.71	0	96
Total	68				240

3. **Section 1 (72 Marks)** of Part A contains a total of 18 **Numerical Answer Type (NAT)** questions. For each question, the answer is a **real number with decimal digits up to two decimal places** that needs to be entered using the virtual keyboard on the monitor. No choices will be shown for these questions. There is **NO NEGATIVE MARKING** for this section. Questions from 1 to 18 belong to this section.
4. **Section 2 (72 Marks)** of Part A contains a total of 18 **Multiple Select Questions (MSQ)**. Each question may have **one or more than one correct choice(s)** out of the four given. A question is considered correctly answered if ALL the correct choices and NO wrong choices are selected for that question. There is **NEGATIVE MARKING** for this section. There is NO PARTIAL MARKING for this section. Questions from 19 to 36 belong to this section.
5. **Section 3 (96 Marks)** of Part A contains a total of 32 **Multiple Choice Questions (MCQ)**. Each question has four choices out of which ONLY ONE is correct. There is **NEGATIVE MARKING** for this section. Questions from 37 to 68 belong to this section.
6. **Part B (60 Marks)** contains one drawing question. There is **NO NEGATIVE MARKING** in this section. Answers to **Part B** have to be given in the **answer book** provided by the invigilator.
7. Calculators, charts, graph-sheets, mathematical tables, mobile phones, smart watches and/or other electronic gadgets are **NOT** allowed in the examination hall.
8. Blank sheets of paper will be provided for rough work.

PART A

Section 1: Numerical Answer Type (NAT)

questions

Section 1 (72 Marks) of Part A contains a total of 18 **Numerical Answer Type (NAT)** questions. For each question, the answer is a real number that needs to be entered using the virtual keyboard on the monitor. No choices will be shown for these questions. There is **NO NEGATIVE** marking for this section. Each correct answer will be awarded 4 marks. Questions that are not attempted or answered incorrectly will be given zero mark. Questions from 1 to 18 belong to this section.

- Q.01** Four identical pieces of wood of length 50 cm x 8 cm x 2 cm are arranged as shown in the figure. Another larger square is generated by rotating all the wooden panels along the outer edges and extending the outermost edges till they touch each other. What is the area of this larger square thus constructed?

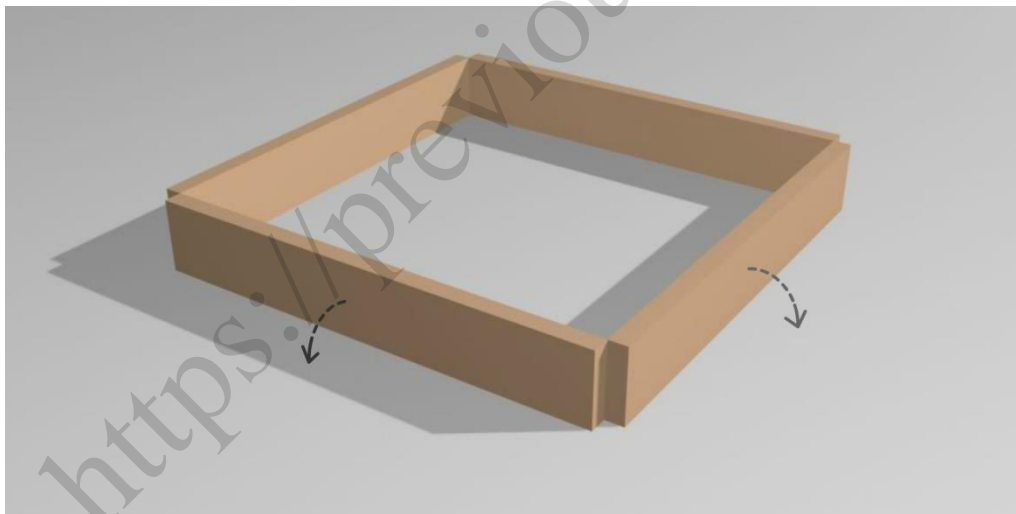

- Q.02** A cricket team has 10 blue pairs of gloves and 10 white pairs of gloves in a cricket kit. If a batter reaches into the kit and pulls out one glove at a time without looking at it, what is the least number of gloves she must pull out to make sure that she has a **pair** of gloves of the **same** colour?

Q.03 Chinnu was excited about the New Year when she bought a new calendar to keep on her study table. While playing, her baby sister poked a hole through the entire calendar from January through December as seen in the image. If every page had the same 5 week table structure for each month, and if all the consecutive months were printed back to back, which date in the month of April has a hole in it?

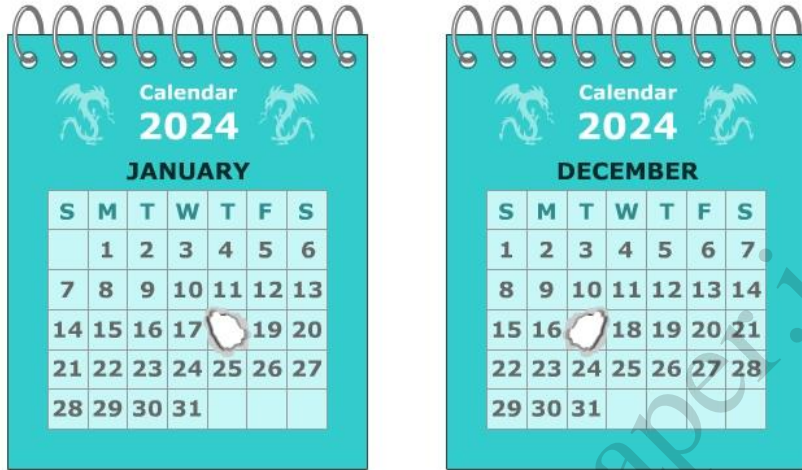

Q.04 How many triangles are there in the figure shown?

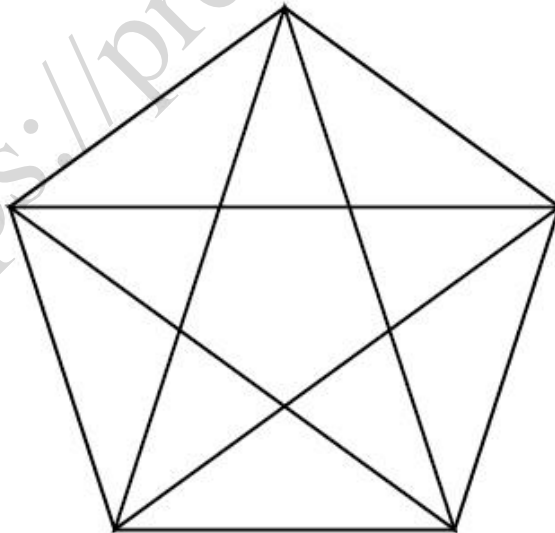

- Q.05** The corners of the green and red triangles coincide with the centres of the circles. All the circles have equal diameters and adjacent circles touch each other. If the area of the green triangle is 3.14, what is the area of the red triangle?

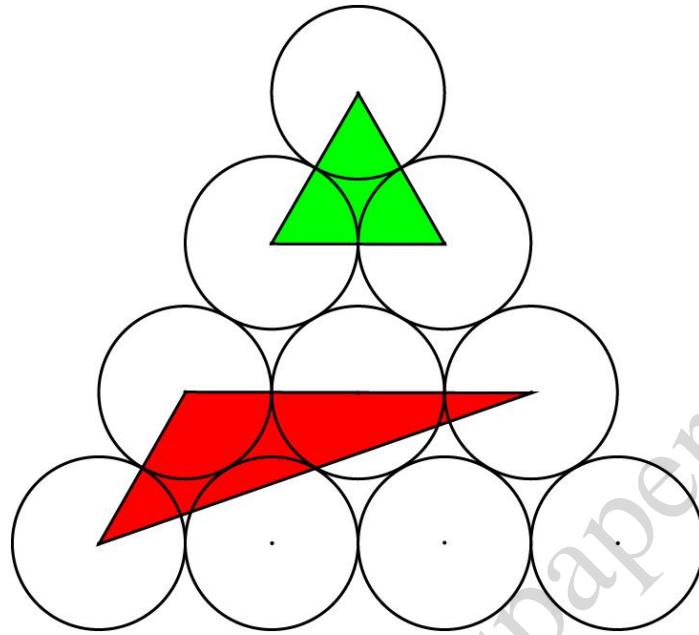

- Q.06** A Street has 13 houses in a row as shown in the figure. Some residents in the first house tested positive for COVID-19. The virus spreads in two ways: it can spread to the next house, or jump directly to the third house. Residents of house number 2 can get infection in only one way, the house number 3 in two ways, the house number 4 in 3 ways, the house number 5 in 5 ways and so on. If the virus **only** progresses from **Left to Right** direction, in how many ways can the residents of the house number 13 get infected?

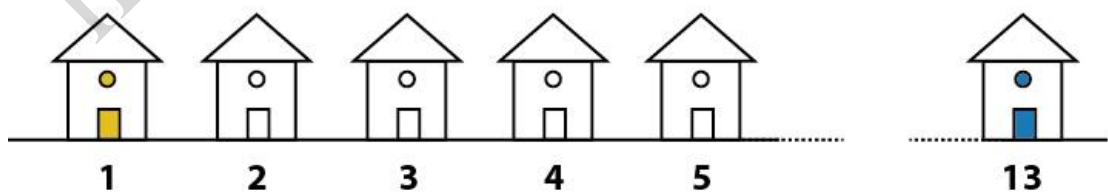

Q.07 In the container given below of dimensions (40 cm X 20 cm X 20 cm), four objects are dipped in water. Objects **P** and **Q** are made of some light material while objects **R** and **S** are made of iron and copper, respectively. The object **P** is a cube of edge 4 cm with $1/10^{\text{th}}$ floating above water; object **Q** displaces 50 cc of water while floating. The volumes of objects **R** and **S** are 295.4 cc and 397 cc, respectively. If all the objects are removed from the container, what would be the new water level inside the container measured from the bottom?

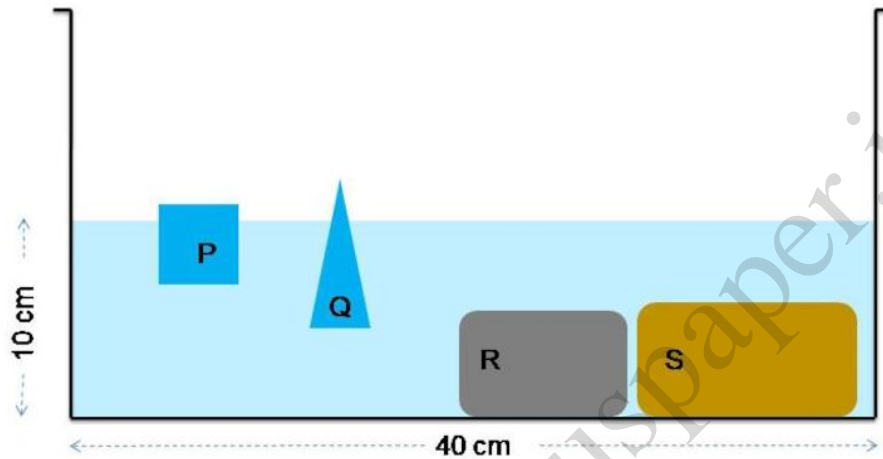

Q.08 If you start from the **circle** and end at the **triangle**, what is the minimum number of straight lines required to pass through all the dots without retracing any route? You are allowed to pass through a dot more than once.

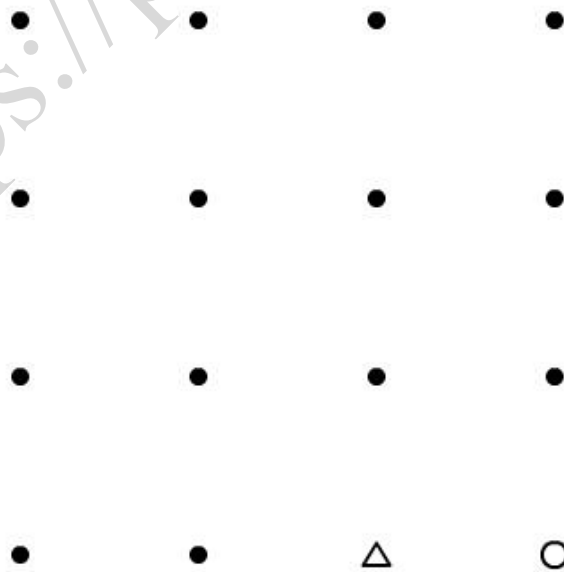

Q.09 If each word is written in a single font and normal and bold versions of the same font are not to be counted separately, how many fonts are used in the given set of words?

पाठव पाठव पाठव पाठव
पाठव पाठव पाठव पाठव
पाठव पाठव पाठव पाठव

Q.10 The figure shows views of the same solid. Count the number of surfaces.

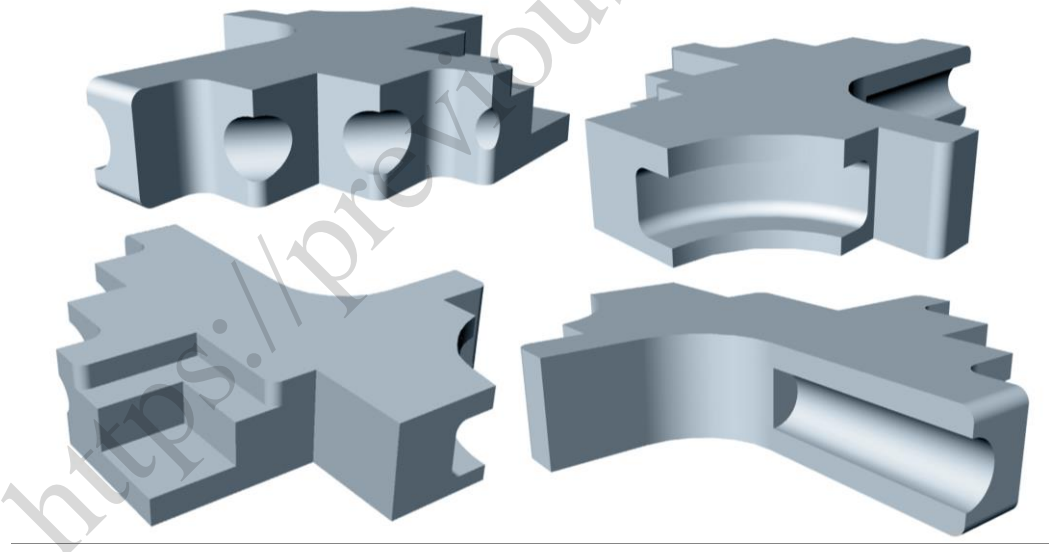

Q.11 There are apples and oranges in a basket that can carry a maximum of 50 fruits. Some fruits are rotten and some are good. The number of rotten apples is twice the number of good apples. The number of good oranges is twice the number of rotten oranges. The number of oranges is thrice the number of apples. If there are more than 40 fruits in the basket, what is the total number of apples and oranges?

Q.12 Four views of a convex solid are shown. How many surfaces does the solid have?

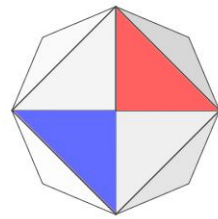

Top view

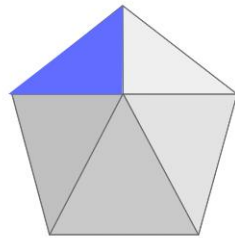

Front view

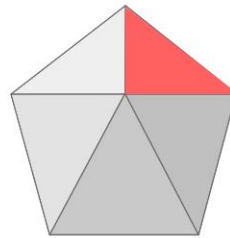

Side view

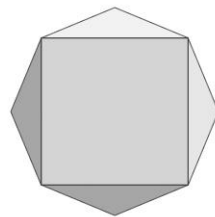

Bottom view

Q.13 When young Moosa started selling dosas on a street corner to support his daughter Lisa's education, his age was six times that of Lisa's. He started selling dosas for ₹2 each and he increased its price by ₹1 every year. Lisa grew up to be a successful lawyer and on Moosa's 60th birthday she gifted him with a small shop near their house, the board of which is seen in the image. In which year Lisa will celebrate her 60th birthday?

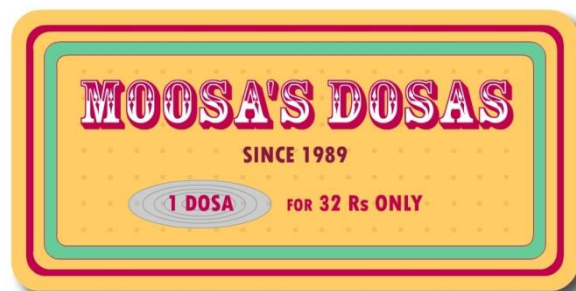

- Q.14** Three circles of radius 10 cm are drawn inside an equilateral triangle as shown below. The area of the red coloured region (in sq. cm., up to two decimal places) in the figure is ____.

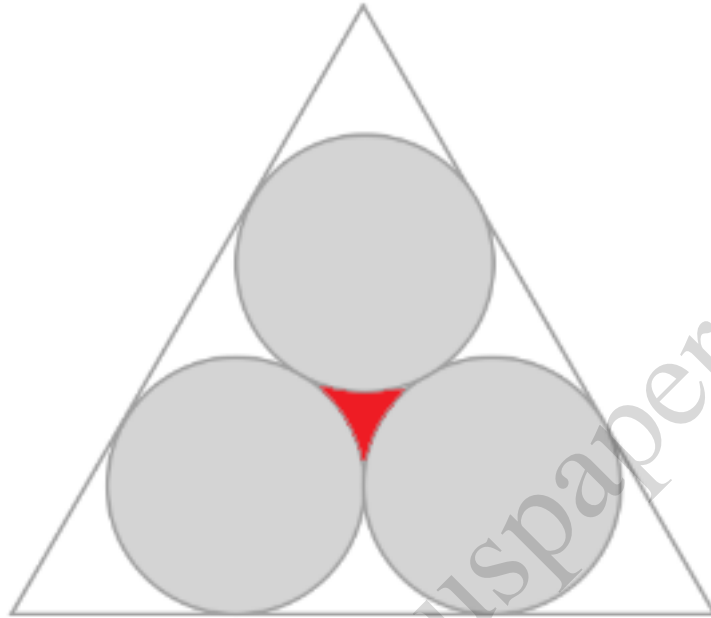

- Q.15** A smaller square of 5 cm is placed inside a bigger square such that all 4 corners of the smaller square are touching the sides of the bigger square. If the smallest distance between the corners of the two squares is 3 cm, what is the area of the bigger square in sq. cm that falls outside smaller one?

- Q.16** A digital clock reads hours and minutes. The sum of the digits it displays at 12:00 is 3 ($1+2+0+0$). At 12:01 it is 4 ($1+2+0+1$) and so on. What is the sum of all the digits it displays from 12:00 to 12:59?

Q.17 A rhombus is inscribed in a rectangle which in turn is inscribed in a circle as shown in the figure below. **P** is the centre of all three shapes, **PQ=QR=5** units. What is the perimeter of the rhombus?

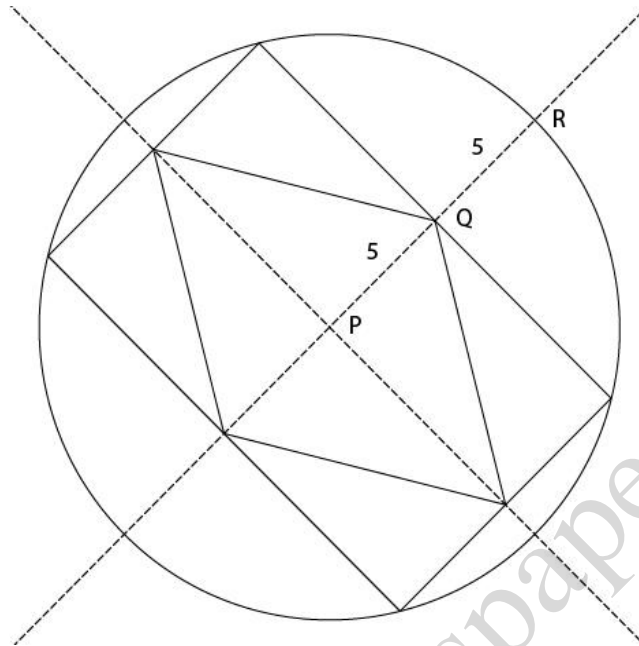

Q.18 If colour and size differences are not to be counted as unique, how many types of leaves occur only once?



Section 2: Multiple Select Questions (MSQ)

Section 2 (72 Marks) of Part A contains a total of 18 **Multiple Select Questions (MSQ)**. Each question may have **one or more than one correct choice(s)** out of the four given. A question is considered correctly answered if **ALL** the correct choice(s) and **NO** wrong choice(s) are selected for that question. There is **NEGATIVE MARKING** for this section. Each question answered correctly will receive 4 marks. Each question wrongly answered will receive -0.19 (minus zero point one nine) mark. There is **NO PARTIAL MARKING** for this section. Questions not attempted will be given zero mark. Questions from 19 to 36 belong to this section.

Q.19 Which of the options is/are rotation(s) of the given figure?

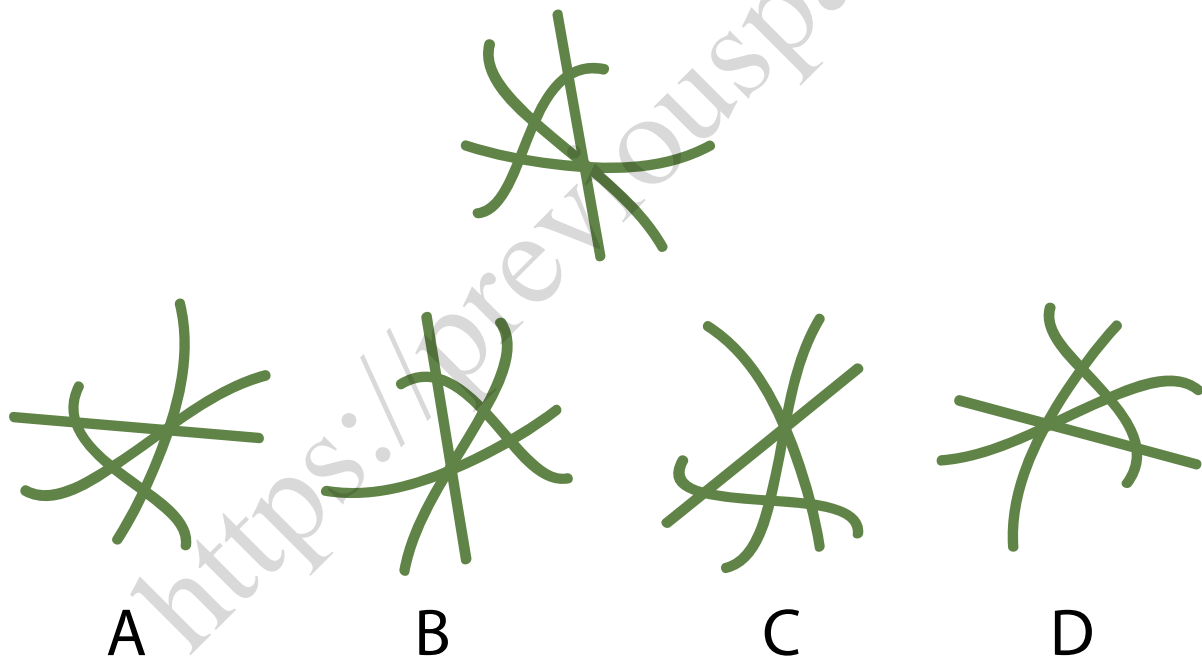

Q.20 Consider the following quote from J C Kumarappa's ***Economy of Permanence***:

"Man comes nearest to his God, the creator, when he utilizes his brain power to marshal mechanical forces to serve his purposes. To do so in a way that will bring blessings and not destruction, he has to follow closely nature's way to get the best out of it. We cannot get the co-operation of nature purely on our own terms. Any attempt to do so will bring violent destruction in its wake."

Which of the options is/are implied by the quote?

- A. Utilizing brain power to marshal mechanical forces to serve our purposes, if not done properly, can lead to destruction.
- B. Utilizing brain power to marshal mechanical forces to serve our purposes can bring man nearest to his God.
- C. While utilizing brain power to marshal mechanical forces to serve our purposes, the best way to proceed is to follow nature's way.
- D. Dealing with nature purely on our own terms will bring violent destruction.

Q.21 Which four pieces of a jigsaw puzzle can be combined to form a square?



- A. 1, 2, 3, 4
- B. 3, 2, 4, 4
- C. 2, 2, 2, 2
- D. 2, 2, 3, 4

Q.22 After retiring, eight friends: Balram, Bhandari, Das, Munshi, Nadkarni, Parmar, Patel and Sethuraman purchased a square plot of land. They divided the land in 8 equal plots and a common back garden as shown. Parmar was allotted plot number 1. Balram preferred a house on the west. Patel chose to stay the farthest from Nadkarni's house. Munshi and Bhandari became neighbours of Nadkarni. Sethuraman became a neighbour of Patel. Nadkarni hails from the North East, so he chose the plot on the North East.

Which of the options MUST BE true?

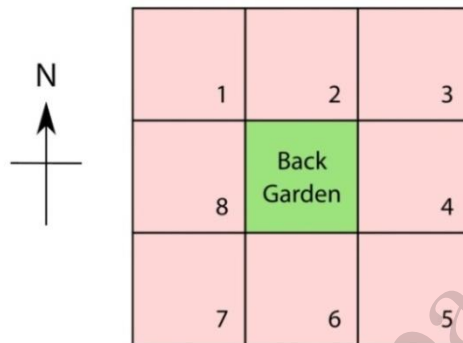

- A. Das stays in plot number 5.
- B. Munshi could be a neighbour of Parmar.
- C. Balram and Nadkarni could be neighbours.
- D. Balram shares a wall with Bhandari.

Q.23 Letters of the alphabet of a font are shown below. The cyan letters H, A and B illustrate how some of them can be folded once to form new shapes. They may be further transformed by rotation. Which of the black shapes given in the options have been folded once and rotated?

A B C D E F G H I J K L M
N O P Q R S T U V W X Y Z



- Q.24** Three friends **P**, **Q** and **R** go for morning walks around a ground. They start out together from the gate in the same direction, but walk at different speeds. **R** walks half as fast as **P**. **Q** walks 1.5 times faster than **R**. **P** takes 1 minute to take one round around the ground. If they all stop when **R** has finished 4 rounds, which of the options must be **true**?

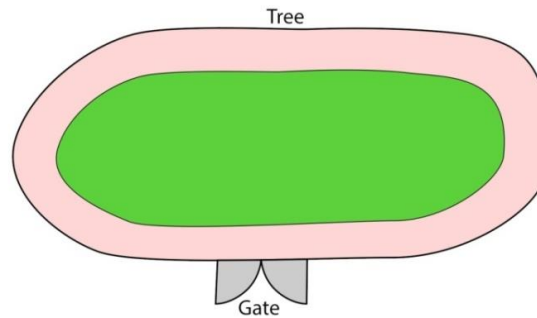

- A. Between the start and the end (not counting the start and the end instances), **P** and **R** meet each other thrice.
- B. Between start and the end (not counting the start and the end instances), **P** meets **Q** only once.
- C. **Q** will overtake **R** once near the Tree.
- D. At the end, **P**, **Q** and **R** will reach the gate at the same time.
- Q.25** Image shows part of a poster made by CDC in the context of COVID-19. Which of the statements is/are true?



- A. It effectively communicates physical distancing.
- B. It is gender neutral. It promotes mask usage.
- C. It is faith neutral and age inclusive.
- D. It effectively communicates all Covid-19 related safety measures.

Q.26 A toy was created using a piece of paper, the two sides of which are shown in the image. When dropped from a height it spins like a fan. Which of the options depict(s) the correct pattern formed while it spins?

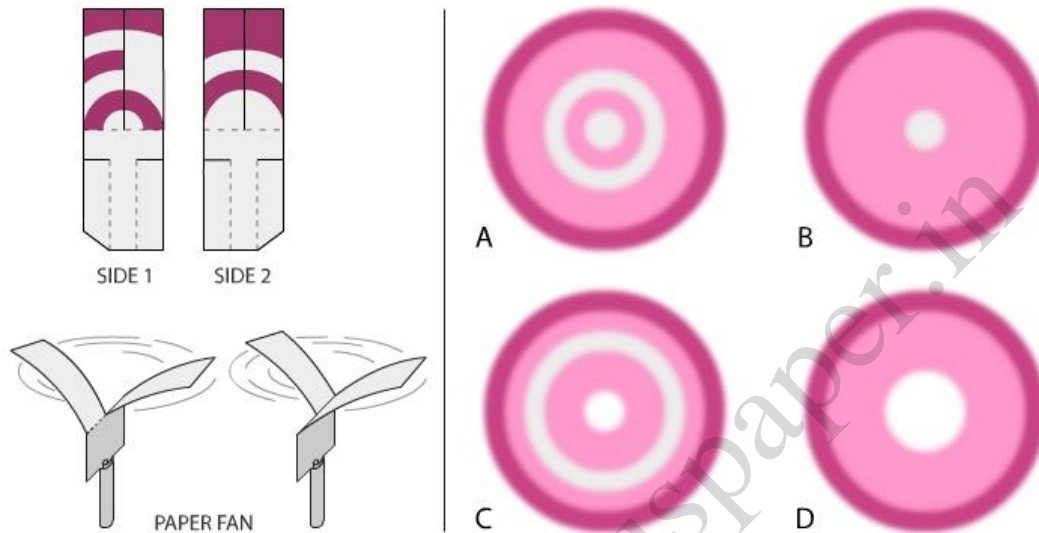

Q.27 Which option(s) can be folded to form the cube shown?

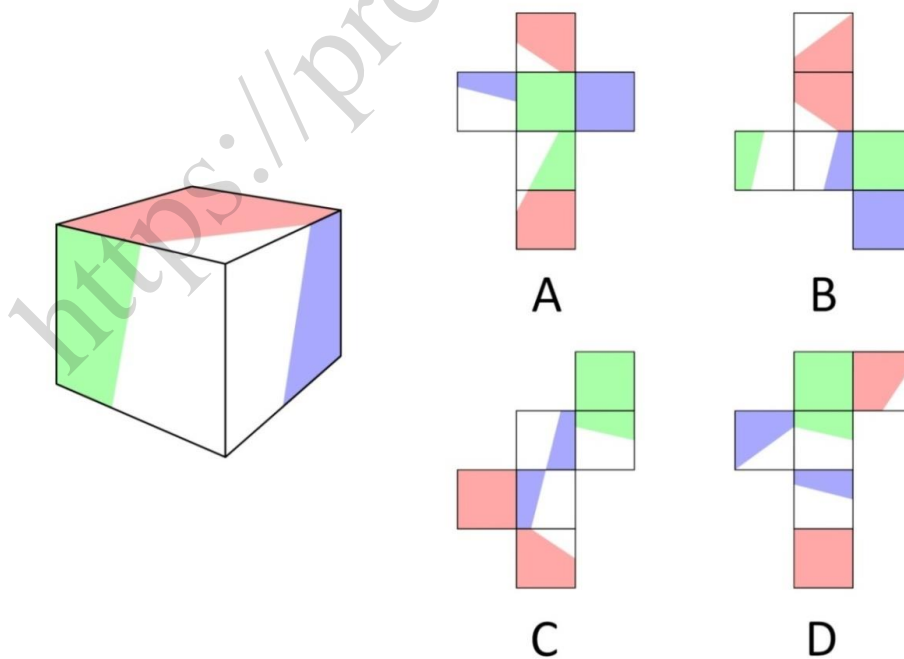

Q.28 Pressure cookers are sometimes made using copper and stainless steel. In such a pressure cooker,

- A. The bottom is made up of stainless steel and the rest is made up of copper because it is aesthetically pleasing.
- B. The bottom is made up of stainless steel and the rest is made up of copper because copper is a germicide.
- C. The bottom is made up of copper because it is a better conductor of heat compared to steel and hence it is more energy efficient.
- D. The bottom is made up of copper because that is the only way such a cooker can be heated using an induction stove.

Q.29 Rep-tile is a shape that can be dissected into smaller copies of the same shape without leaving any remainder. For example a square can be cut into various numbers of smaller copies of square shape.

If no flip is allowed, which of the options is/are rep-tiles?

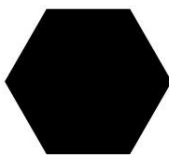

A



B



C



D

Q.30 Which of the object(s) given in the options can produce the top and front view as shown in the figure? Arrow shows the direction of front view.

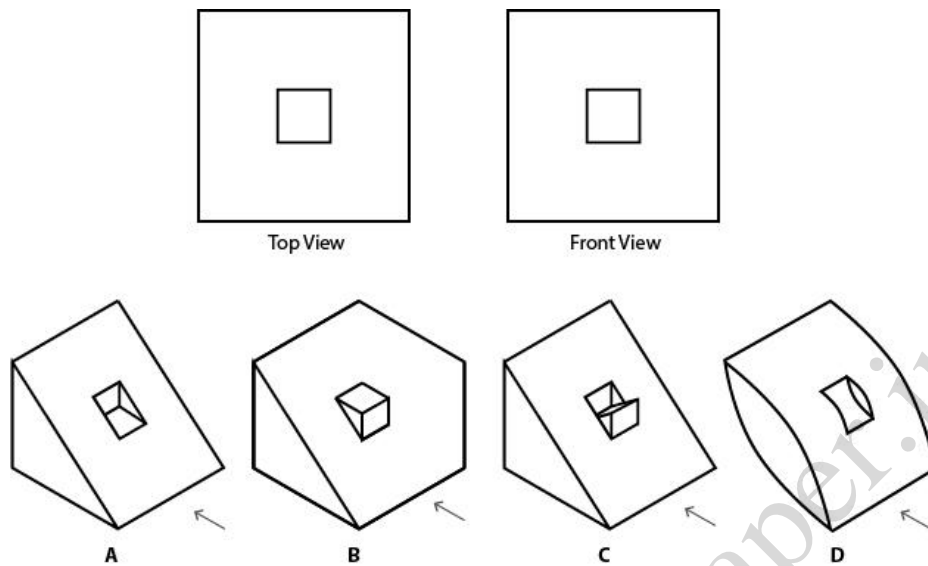

Q.31 [This question contains an animated GIF image. Please refer to that image]

A designer has created an infinitely looping animation as shown in the image. It has 24 frames playing at a speed of 12 frames per second. Which of the statements is/are true?

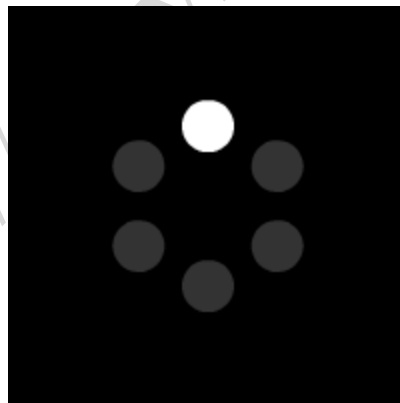

- A. The duration of one circular loop is 3 seconds.
- B. Each dot turns white for 4 frames in each loop.
- C. If this animation is played at 8 frames per second, the speed of animation will be faster.
- D. This animation with same duration is possible with 6 frames played at 3 frames per second.

Q.32 Three squiggles were drawn on three transparent square sheets in semi-transparent ink and piled together. Some sheets may be rotated. Additionally, in some options, some squiggles are different than the ones shown. In which option(s), do the squiggles look different?

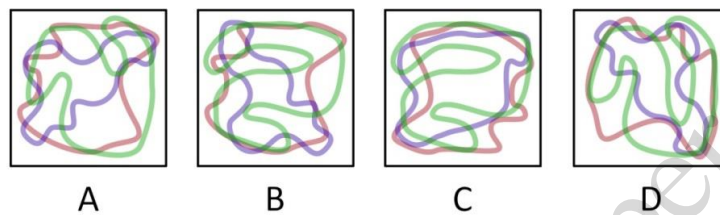
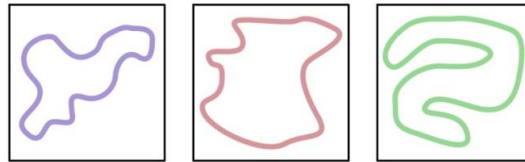

Q.33 A beat policewoman is starting her midnight walk. Starting from the signal **P1**, she heads west and takes the second right. Thereafter, she continues her journey, taking the second left, second left, third right, third right, and after that she goes and ends her beat walk at the next signal. In the given map, some of the intersections have traffic light signals and are marked with dots. Which of the options is/are true?

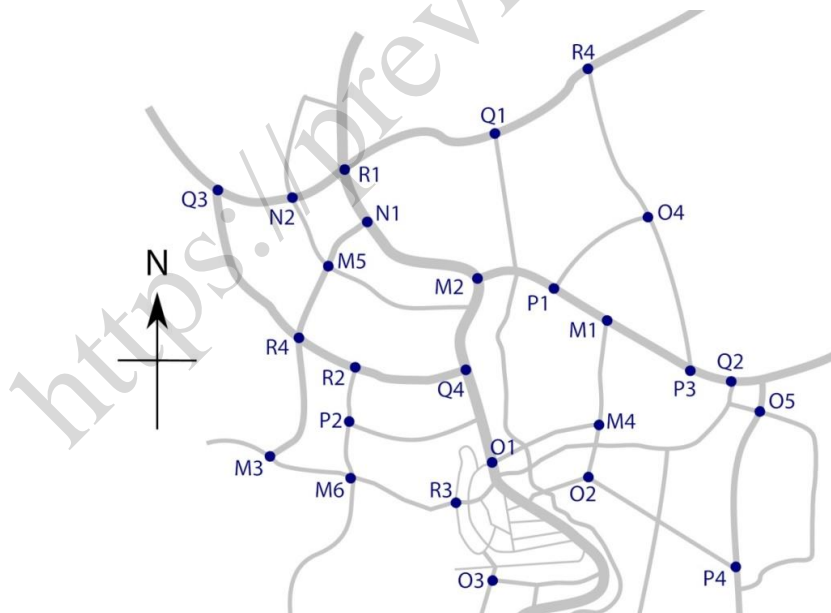

- A. The policewoman visits the signal **M6** twice
- B. She passes signals **M6**, **P2** and **R2** in that sequence
- C. She visits **R4** before **R2**
- D. She ends her beat walk at **R3**

Q.34 Which of the following relationships can be represented using the Venn diagram shown below?

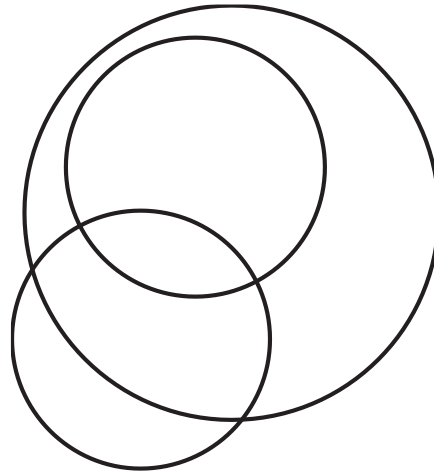

- A. Snack, Food, Dosa
- B. Female, Doctor, Mother
- C. Parrot, Pet, Bird
- D. Designer, Teacher, Painter

Q.35 From one side of a solid cube of side 2 units, a square pyramid of height 1 unit was removed as shown in the image, resulting in a solid with 9 surfaces. If one more pyramid of the same dimensions is removed from another side of the resultant solid, how many surfaces can the new resultant solid have?

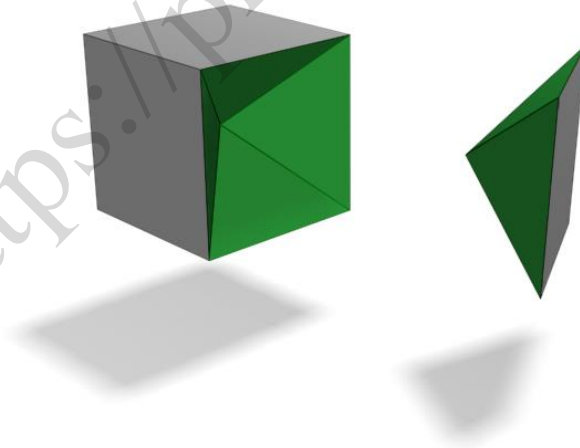

- A. 10
- B. 11
- C. 12
- D. 13

Q.36 If a solid octahedron as shown in the figure is cut by a plane into two pieces, what is/are the possible shape(s) of the cross-section?



- A. Triangle
- B. Square
- C. Pentagon
- D. Hexagon

Section 3: Multiple Choice Questions (MCQ)

Section 3 (96 Marks) of Part A contains a total of 32 **Multiple Choice Questions (MCQ)**. Each question has four choices out of which **ONLY ONE** is the correct answer. There is **NEGATIVE MARKING** for this section. Each correct answer will be awarded 3 marks and each wrong answer will receive -0.71 (minus zero point seven one) mark. Questions not attempted will be given zero mark. Questions from 37 to 68 belong to this section.

- Q.37** Consider the configuration in the given figure. If rotating and flipping are **not** allowed and pieces given in an option need not be placed in the given sequence, which combination would complete maximum number of horizontal black rows?

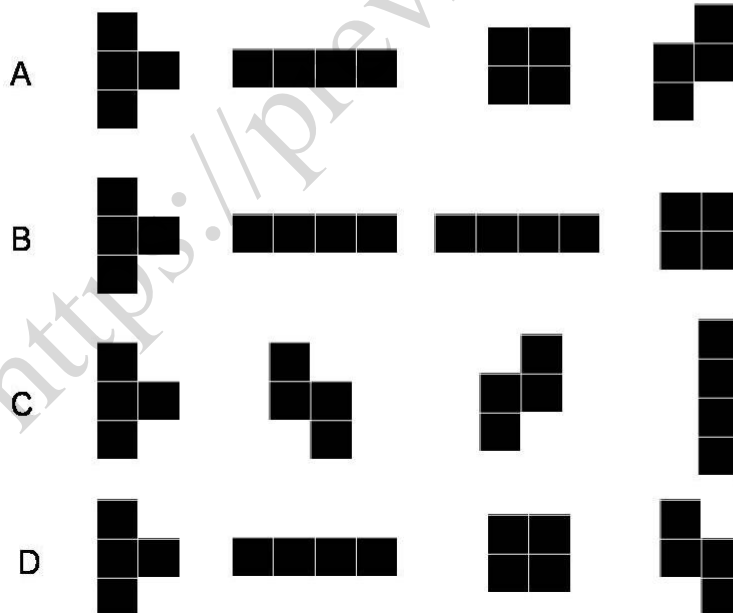

Q.38 Which of the options is the correct logo?

Amul

A

Amul

B

Amul

C

Amul

D

Q.39



P



Q



R



S

- A. **P** – Mauryan Empire, **Q** – Pallava Empire, **R** – Vijayanagar Empire, **S** – Mughal Empire
- B. **P** – Mughal Empire, **Q** – Vijayanagar Empire, **R** – Chola Empire, **S** – Mauryan Empire
- C. **P** – Mauryan Empire, **Q** – Chola Empire, **R** – Vijayanagar Empire, **S** – Mughal Empire
- D. **P** – Mauryan Empire, **Q** – Chola Empire, **R** – Bahmini Sultanate, **S** – Mughal Empire

Q.40 Figure on the left represents a screen from a shadow puppetry show with the ARRANGEMENT 1 behind the screen. Which of the options will be the closest representation of the screen as a result of ARRANGEMENT 2?

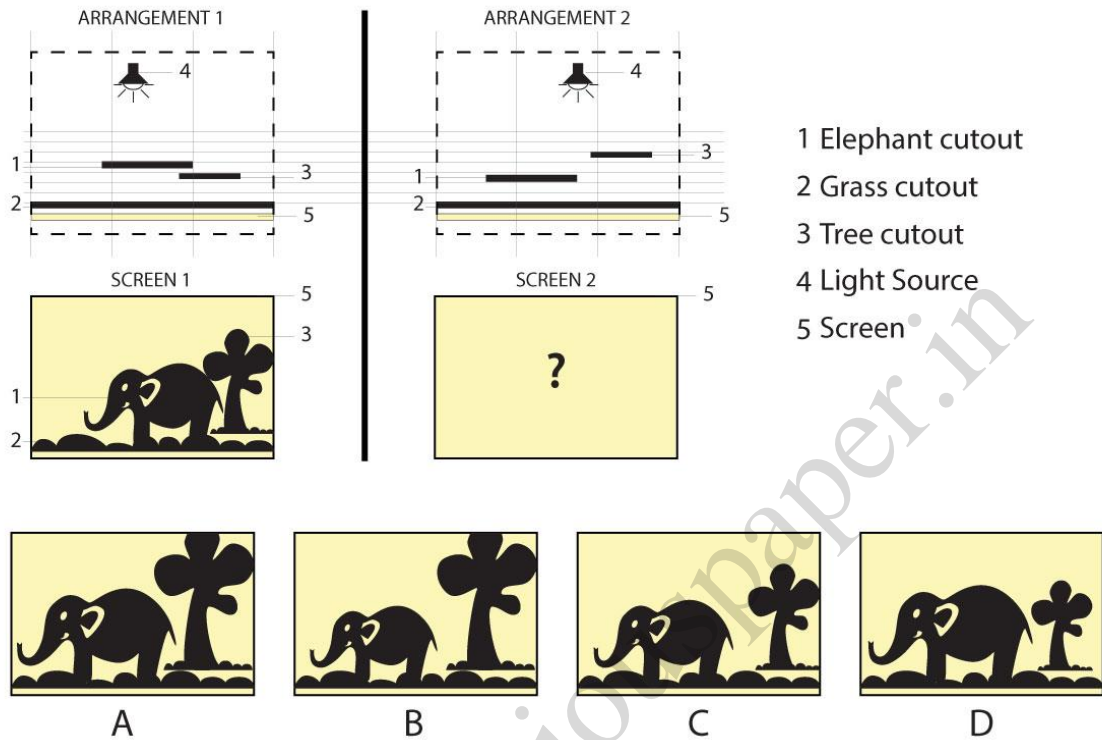

Q.41 The handle was erased from the drawing of a mug. Which of the options represents the part that was erased?

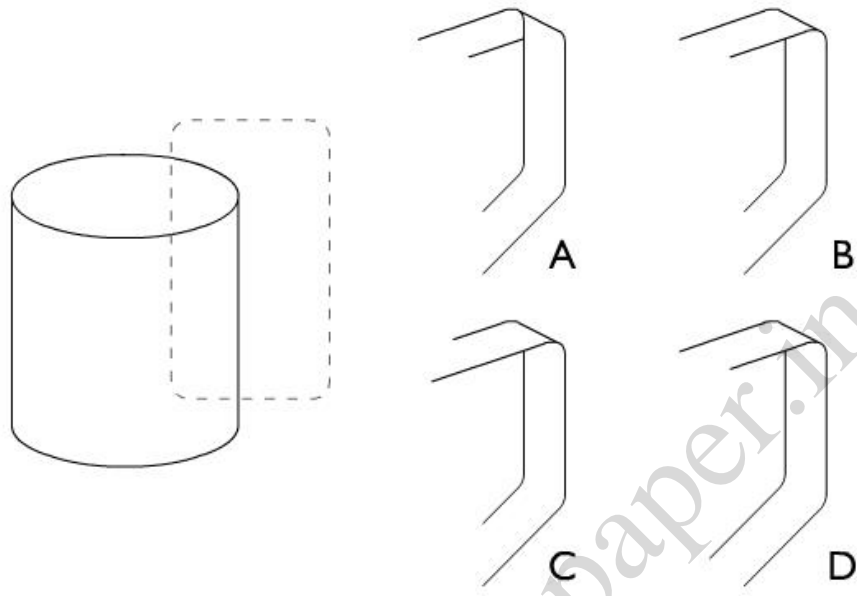

Q.42 Which of the options will replace the question mark in the given sequence?

F K ? U Z

- A. **C**
- B. **O**
- C. **P**
- D. **R**

Q.43 Two of the three lines shown below indicate the tracks made by a bicycle. Identify which is the front tyre track and which is the rear tyre track.

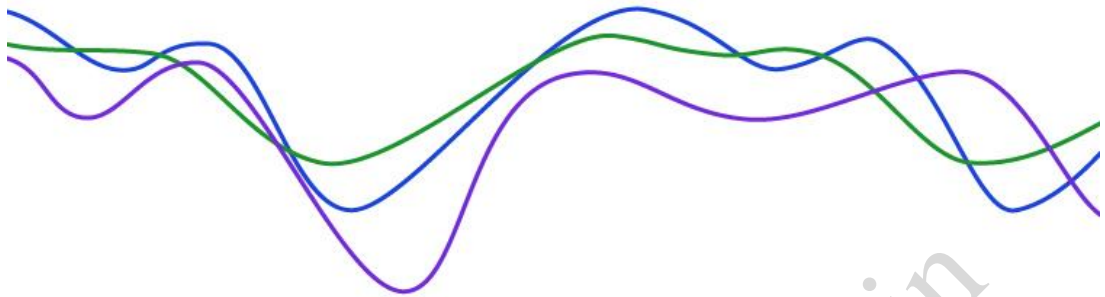

- A. Green is front, Purple is rear
- B. Green is front, Blue is rear
- C. Blue is front, Green is rear
- D. Blue is front, Purple is rear

Q.44 An artwork on a paper creates an illusion of a ladder resting on a wall when the paper is folded and viewed from a specific angle as shown in the image. Which of the options correctly depicts this artwork on the paper when unfolded?

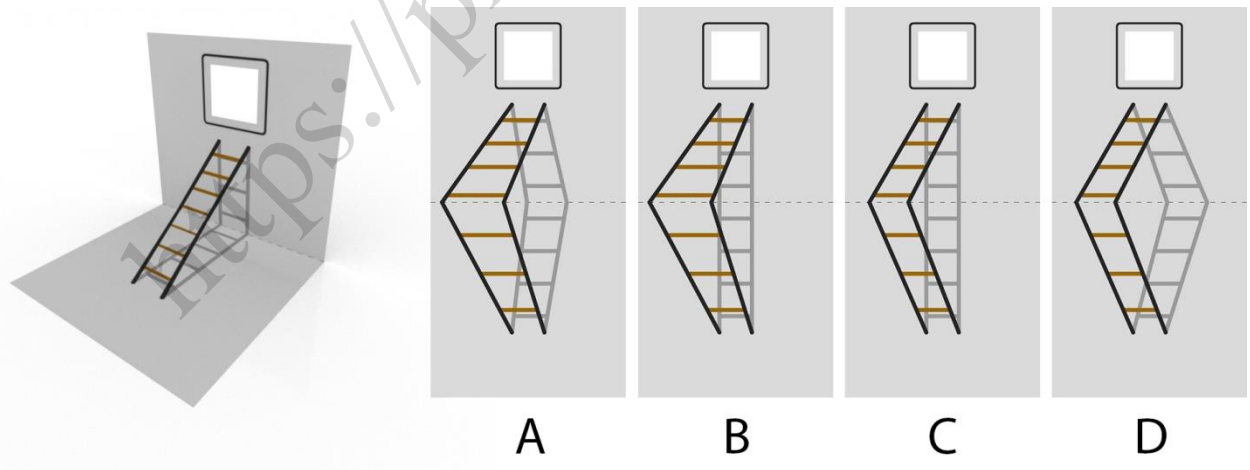

Q.45 On a race track shown below choose the correct starting configuration. The athletes are not allowed to change the tracks. Each grid is 2 m x 2 m.

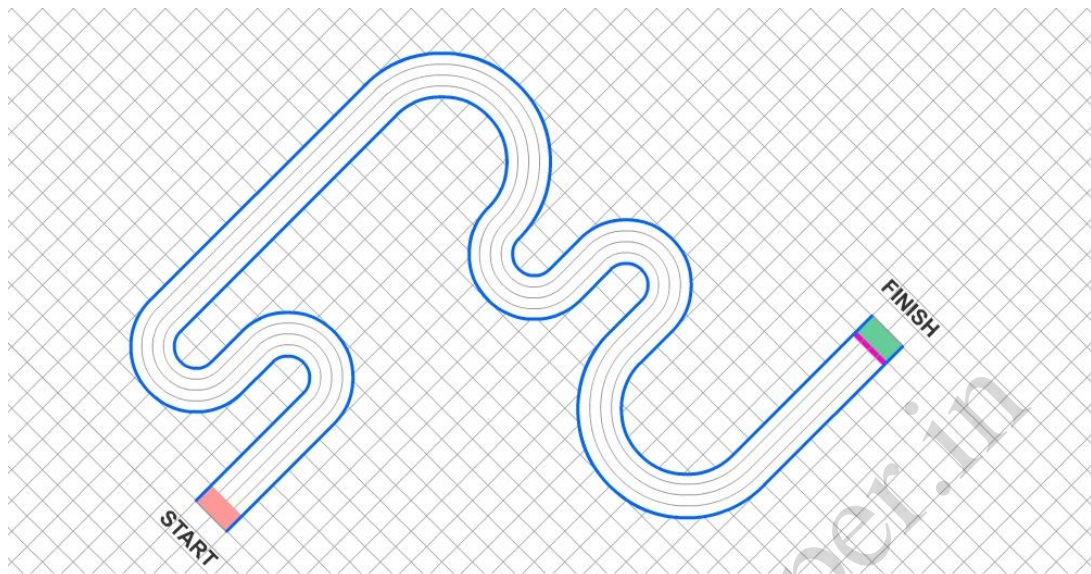

Q.46 Two identical cubes **P** and **Q** are made of smaller cubes in $3 \times 3 \times 3$ and $5 \times 5 \times 5$ configurations, respectively as shown below. Alternate cubes are painted green and white as indicated. Identify the correct option.

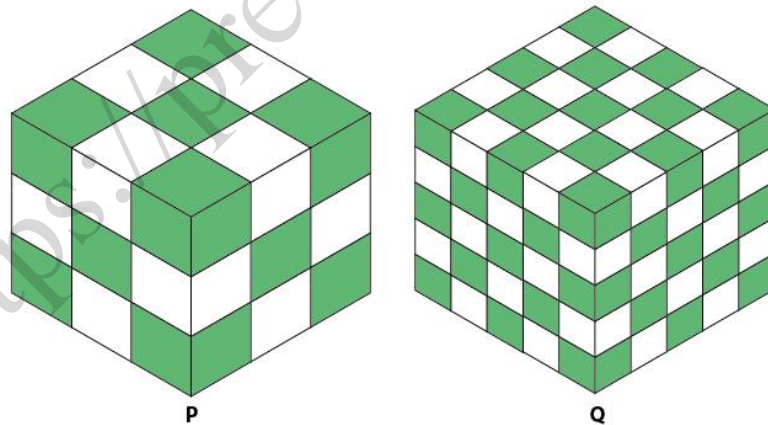

- A. The surface area of green is more in **P** than in **Q**
- B. The surface area of white is more in **P** than in **Q**
- C. The surface areas of green and white are the same in **P** and **Q**
- D. The surface area of green is the same but the area of white is different in **P** and **Q**

Q.47 The image shows the top views of an L shaped sculpture resting on a planar ground. When light falls on it at an angle of 45 degrees from the ground in the directions marked as an arrow in the image, the corresponding shadows are formed on the ground. Which of the options is this sculpture?

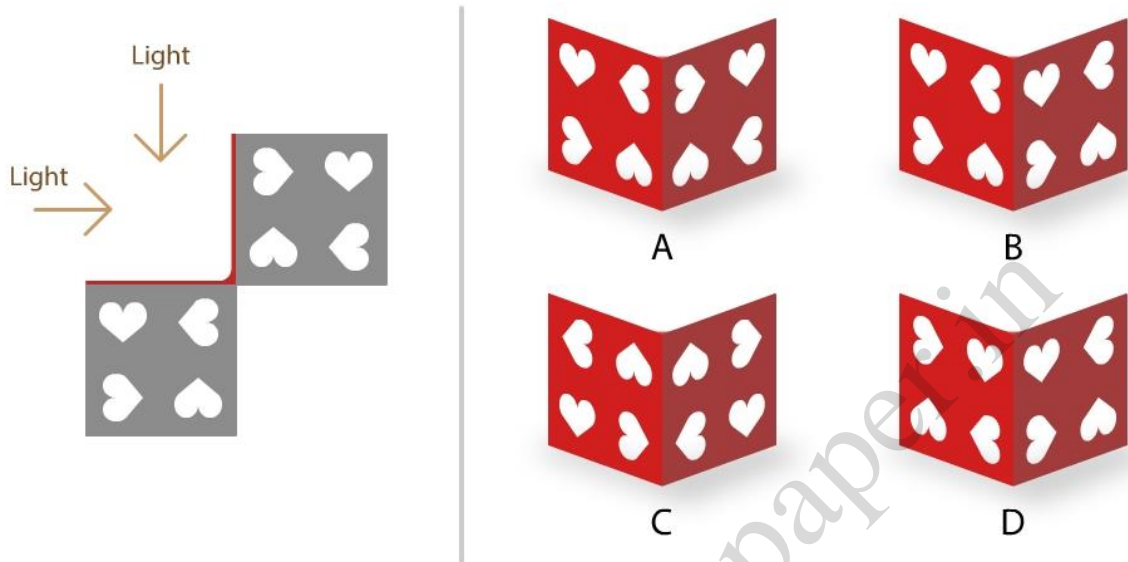

Q.48

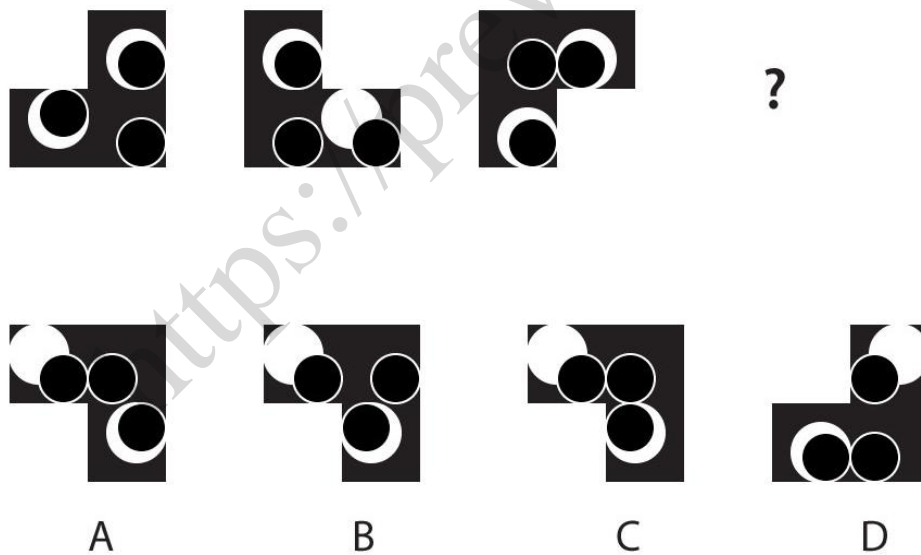

Q.49 An animator was trying out options of various rough poses while planning a frame of a shot. Mirroring and silhouetting are two aspects that animators need to consider when deciding whether a pose is good or not. (The left and right side having the same pose, i.e. mirrors of one another is called Mirroring. Silhouetting refers to the shape of the pose if it was a silhouette, i.e. the outline of the pose.) Based ONLY on these two aspects, which of the options can be considered the **WEAKEST** pose?

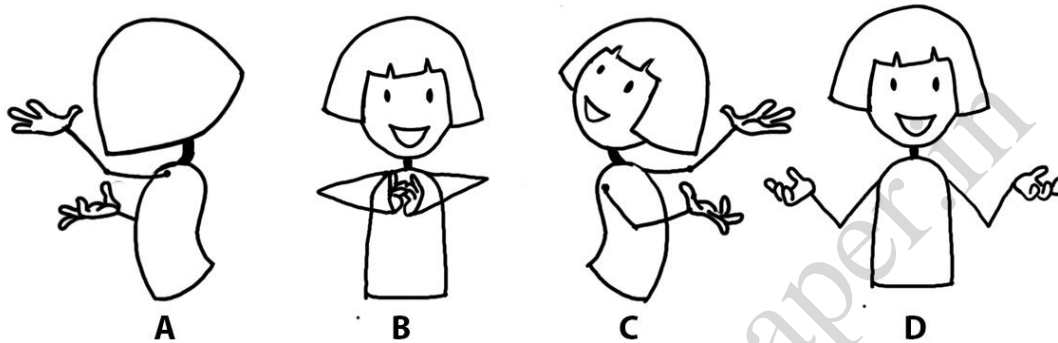

Q.50 At 6:00 pm, the hour hand and the minute hand of an analog clock are at 180 degrees with each other. After approximately how much time will they be at 180 degrees with each other again?

- A. 48 minutes, 40 seconds
- B. 54 minutes, 33 seconds
- C. 60 minutes
- D. 65 minutes, 27 seconds

Q.51 Which of the kettles shown below can hold the most amount of water when placed on an even, horizontal surface?

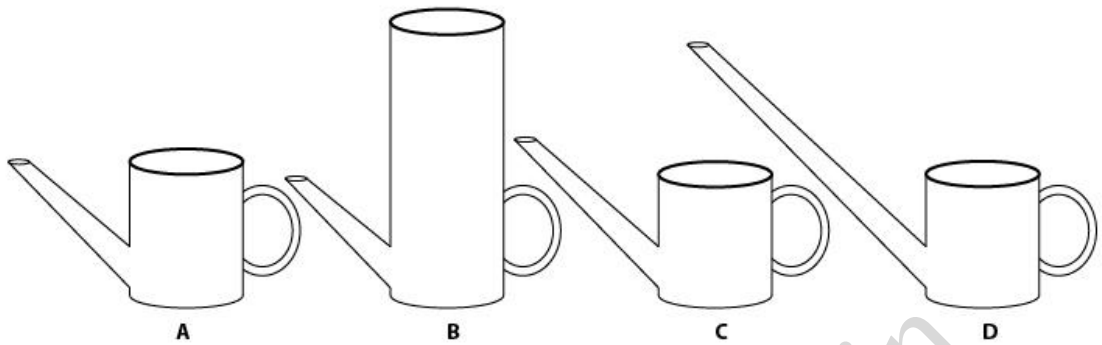

Q.52

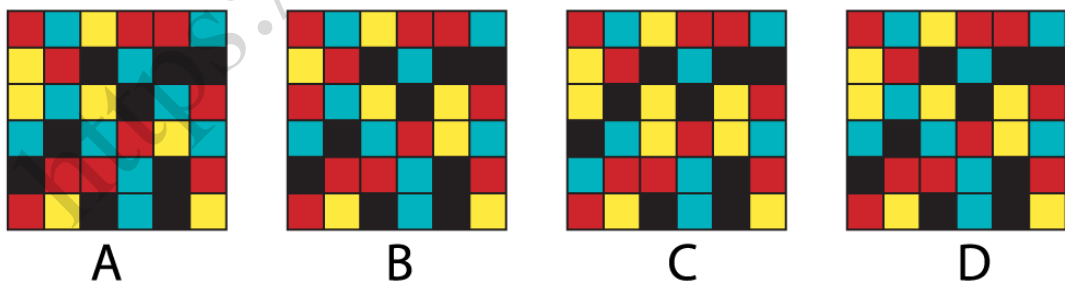
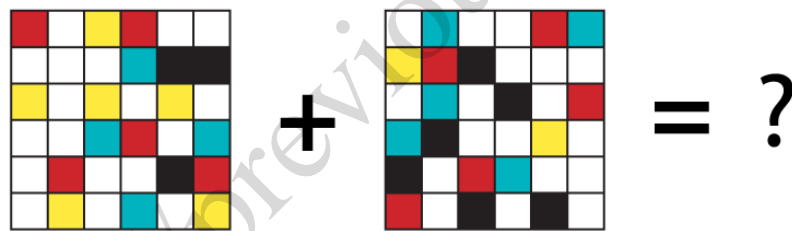

Q.53 A plane is landing smoothly on the airport runway. Select the correct picture.

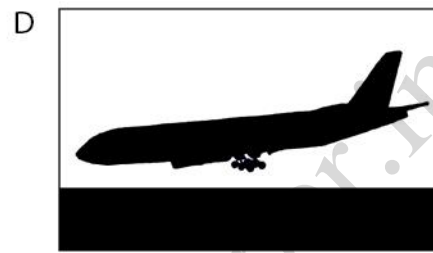
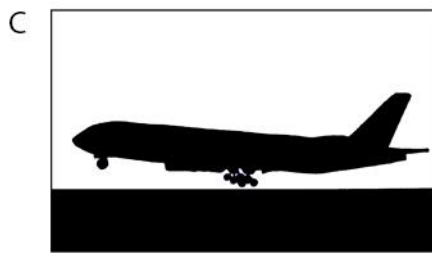
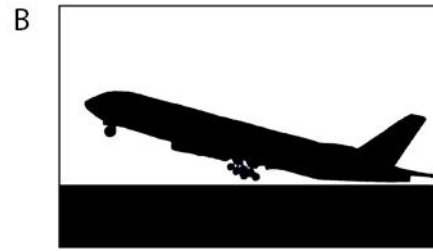
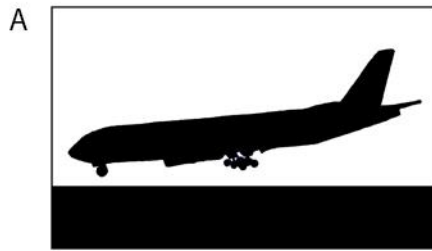

Q.54 In the series given, the first is an equilateral triangle, the second becomes a square by rearranging the pieces, and the third becomes a regular pentagon **without any rotation**. Similarly, the fourth becomes a regular hexagon. Which of the options given therefore replaces the question mark?

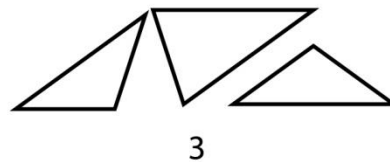
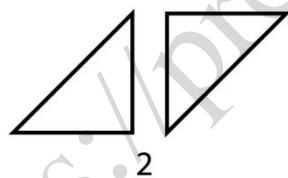
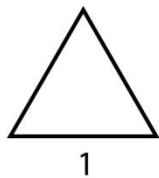

?
4

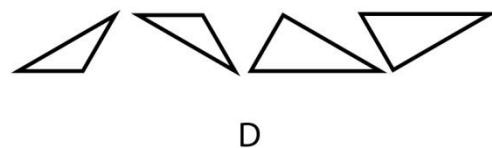
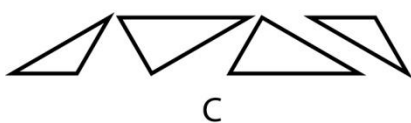
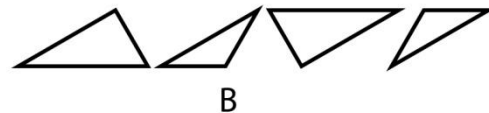

- Q.55** Perspective view of an object is shown. The object is rotated with respect to the fixed coordinate system as indicated:
 90 degrees clockwise about **x**-axis, 90 degrees anti clockwise about **y**-axis, 90 degrees anticlockwise about **z**-axis. All rotations are when viewed from a point on the positive axis towards the origin. Which one of the following perspective view options will be the result of the rotations?

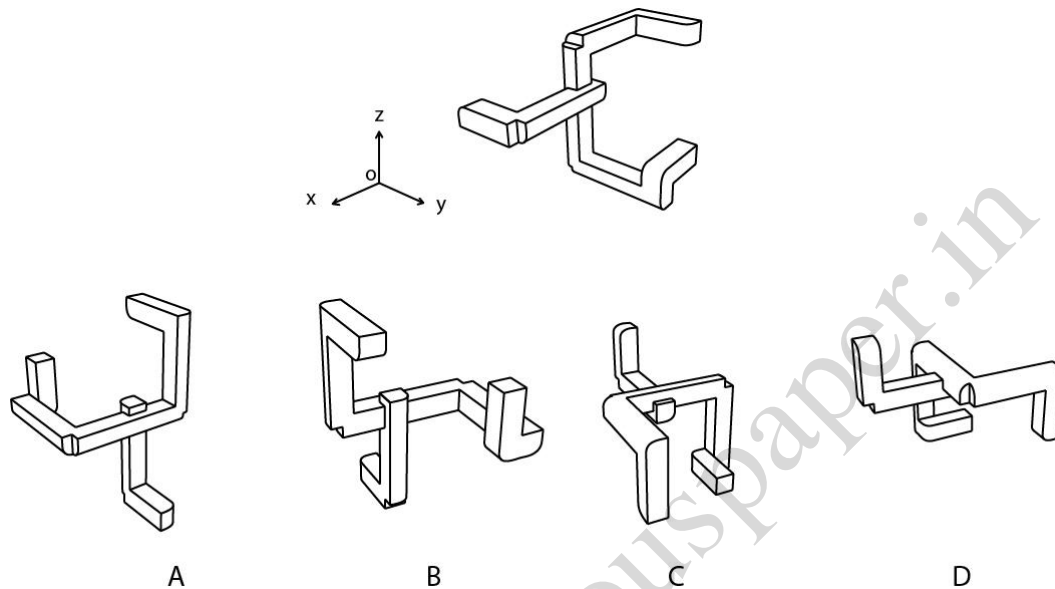

- Q.56** A car moves along a curving road at constant speed. Which of the following graphs correctly show(s) the movement of the car in the X direction with respect to time?

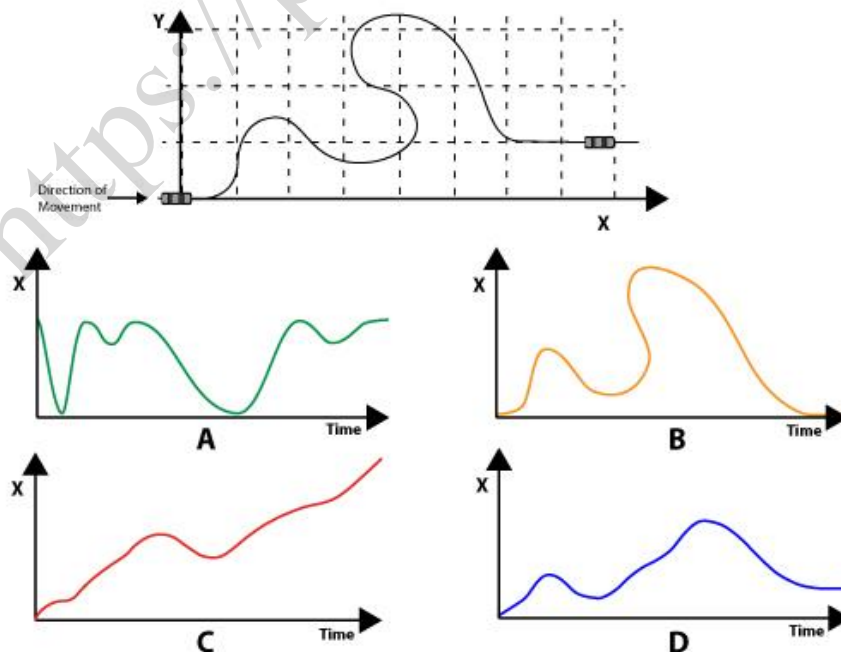

Q.57 Five small triangles of equal size are fitted in a large triangle as shown below. Approximately what percentage (%) of area in the large triangle is **empty**?

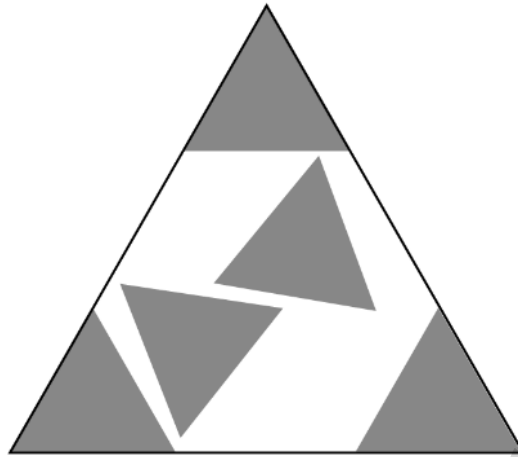

- A. 33
- B. 44
- C. 55
- D. 66

Q.58 The image below shows the developed surface of a cube. Which of the options will **NOT** open up as the shown image?

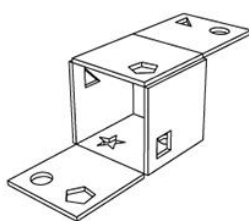
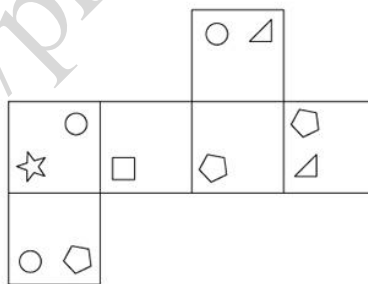

A

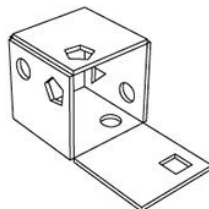

B

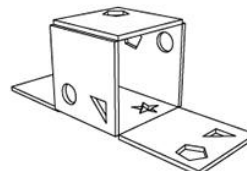

C

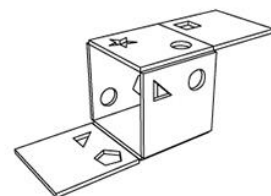

D

Q.59 A frame of a bouncing ball is shown in the picture. This shows the animation principle of _

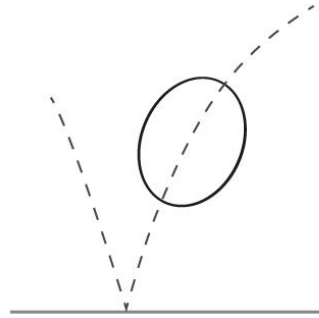

- A. Stretching Principle
- B. Distortion Principle
- C. Squash and Stretch Principle
- D. Motion Principle

Q.60 Two paper loops are joined together as shown in the figure below. If you cut the loops along the blue dotted line, what will be the resultant figure?

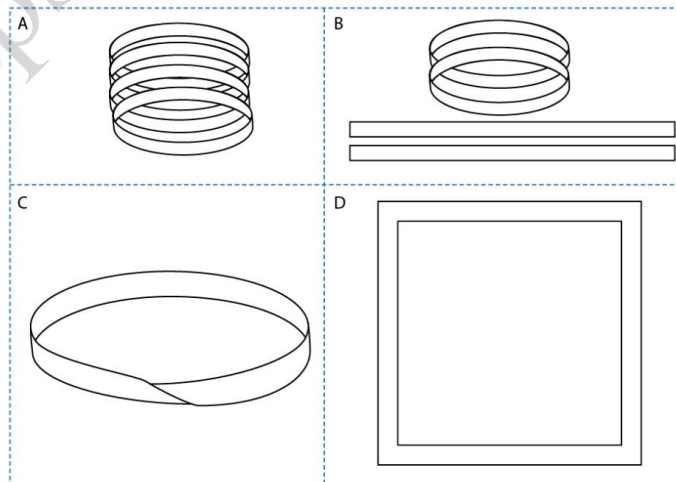
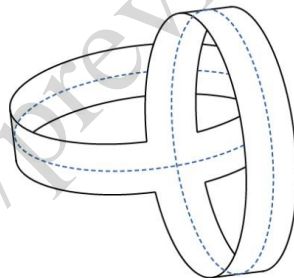

Q.61 Reference image of a square pyramid, P, is provided on the left. Assume Q as an identical pyramid created by mirroring P in upward direction. Q was rotated by 135 degrees around the vertical axis and then brought down so that the two pyramids intersect. Which of the options is the resultant view as seen from the given direction arrow?

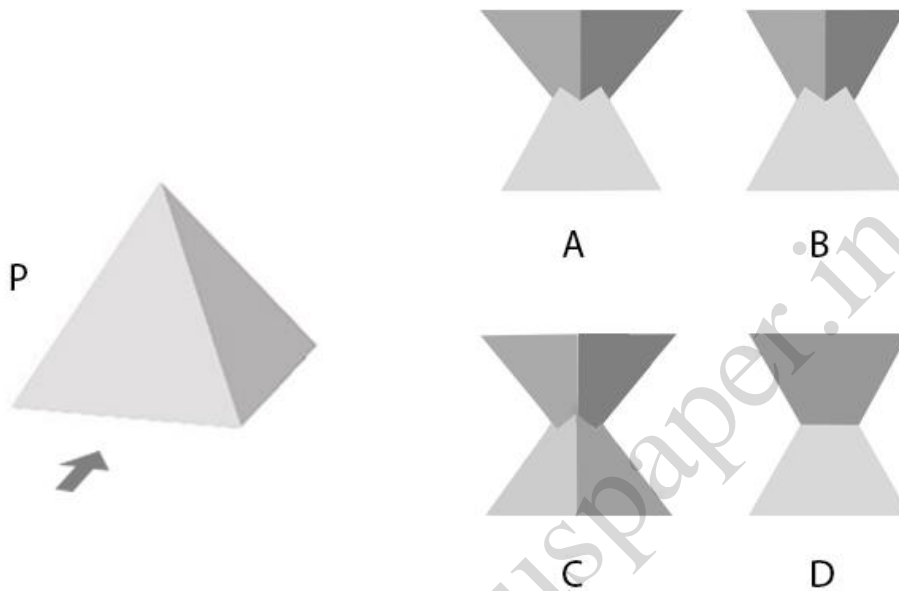

Q.62 Figure shows the top view of a cylinder with mirror finish kept on a paper on which the word 'WARD' is written. Which of following images is the best representation of the word and its reflection?

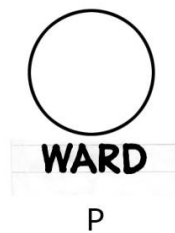

Q.63 Which letter is **NEVER** used while printing the calendar mentioning names of all the days of the week and months in full form?

- A. **W**
- B. **G**
- C. **K**
- D. **V**

Q.64 Which option depicts the reflection of the figure given below?



- | | | | |
|---|--|---|--|
| A | | C | |
| B | | D | |

Q.65 Three white squares overlap the cyan square such that one of their corners meet at the centre of the cyan square as shown in the figure. What is the ratio of the area of the shaded portion to the original cyan square?

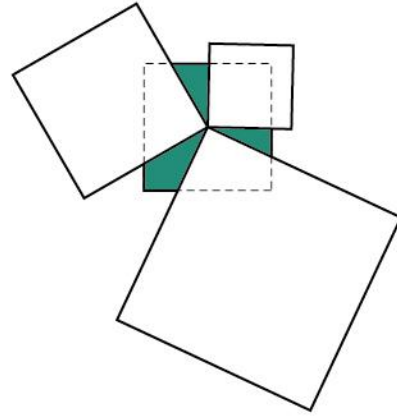

- A. 1/6
- B. 1/4
- C. 1/3
- D. 3/8

Q.66

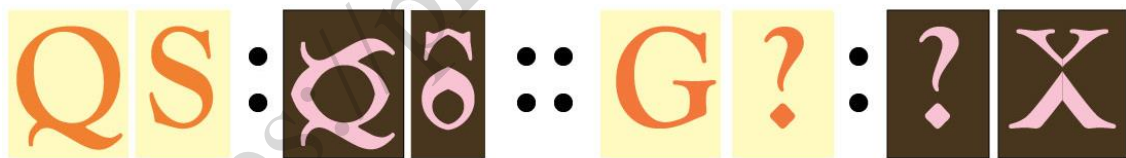

- | | | | |
|---|--|---|--|
| A | | C | |
| B | | D | |

Q.67 **P, Q, R, S** are competing in the slow cycle race, in which the slowest cyclist wins. A few minutes after the race begins, **P** is physically ahead of **Q**. **R** and **S** are physically behind **Q**. **S** is physically ahead of **R**. **P** got eliminated and **R** overtakes **Q**. Just reaching before the end mark, **S** overtakes **Q**. Which of the options is true?

- A. **R** is winner
- B. **S** is winner
- C. **Q** is winner
- D. **Q** is runner up

Q.68 Select the correct logo

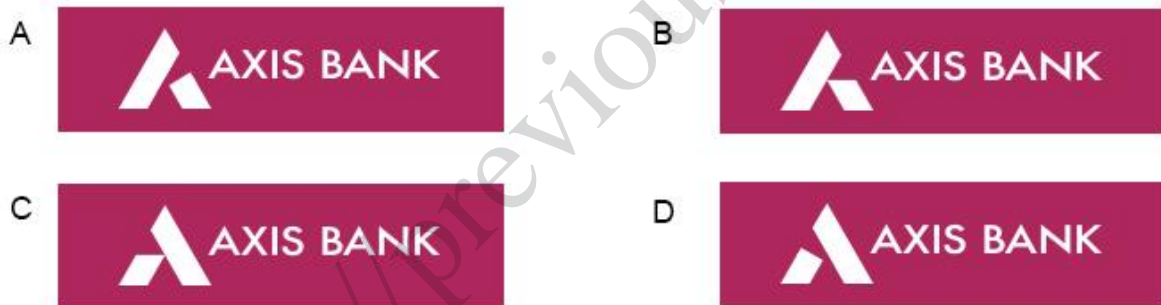

PART B

Mandatory question

Q.1 Sketching

(30 minutes – 60 marks)

[Note:

- 1) This question must be answered in the answer booklet provided by the invigilator
- 2) It is not mandatory for the candidates to mark the Part-B question as 'answered' at the bottom of the screen on the computer]

You are sitting in a well ventilated drawing room. It is 9 in the morning and sun light is streaming through the window on the East casting shadows on the floor. A cat is resting on one of the sunlit patches. A newspaper is placed beside a cup of hot tea on a small side table. There are three freshly watered potted plants in the room; one on the floor and two on the window sill with the watering jug next to it.

From the above description, sketch the scene from your point of view.

Note:

- Make pencil sketches only
- Do not use colours

Evaluation Criteria:

- Observation
- Imagination
- Selection & composition of objects
- Quality of line
- Presentation
- Attention to detail

UCEED 2021
FINAL ANSWER KEY

SECTION – A (NAT)

Q. No.	KEY RANGE	Q. No.	KEY RANGE	Q. No.	KEY RANGE	Q. No.	KEY RANGE	Q. No.	KEY RANGE
01	4900	02	21	03	16	04	35	05	6.28
06	233	07	9	08	6	09	7	10	21
11	48	12	13	13	2044	14	16.12 (15.00~16.50)	15	24 OR 49
16	600	17	40	18	2				

SECTION – B (MSQ)

Q.No.	KEYS	Q.No.	KEYS	Q.No.	KEYS	Q.No.	KEYS	Q.No.	KEYS
19	A,D	20	A,B,C,D	21	C,D	22	A,B	23	B,C,D
24	A,B,D	25	A,B	26	B,C	27	B,C	28	C
29	B,C,D	30	A,B,C,D	31	B,D	32	A,C	33	C,D
34	B,C	35	A,C	36	B,C,D				

SECTION – C (MCQ)

Q.No.	KEY	Q.No.	KEY	Q.No.	KEY	Q.No.	KEY	Q.No.	KEY
37	C	38	D	39	C	40	B	41	B
42	C	43	C	44	C	45	C	46	A
47	D	48	B	49	B	50	D	51	A
52	D	53	C	54	C	55	A	56	C
57	B	58	B	59	C	60	D	61	A
62	A	63	C	64	D	65	B	66	D
67	C	68	B						